

STEINMANS SAFETY BLIND - RAISED FACE OR PLAIN FACE FLANGES

| | | | |
|---------------------|------------------------------------|--|-------------------------|
| Client Name: | Provided by: Steinmans, LLC | Item No.: SB-0150-04HF-0050-316SS | Revision: REV-01 |
| Company: | Prepared by: DSF | Design Type: STEINMANS Safety Blind | Date: 09/17/2010 |

- Quantity: 1
 Item Description: STEINMANS Safety Blind
 Line Size, NPS: 1/2
 Material of Blank/Spacer: ASTM A 240 Gr. 316 Stainless Steel Pl. 16Cr-12Ni-2Mo
 Flange Class Rating: Class 150
 Facing Type: Plain Face
 Facing Finish: Mill Finish
 *Standards: (a) ASME B16.5 Flanges, NPS 1/2 thru 24
 (b) ASME B16.48 Line Blanks
 (c) ASME B31.3 Process Piping
 Dimensional Tolerance: +/- 0.03 in.
 Thickness Tolerance: ASTM Plate Standard
 Weight Density (lb/in³): 0.289
 Corrosion Allowance: 0.000 in.
 Design Temperature: N/A
 Allowable Pressures (psig): NOT RATED FOR PRESSURE
 Construction of Design: One Piece Construction
 Material of Handle/Web: N/A - Handle Not Separate (One Piece Construction)
 Welding Requirements: No Welding Required (One Piece Construction)
 Coating: None
 Special Features: None

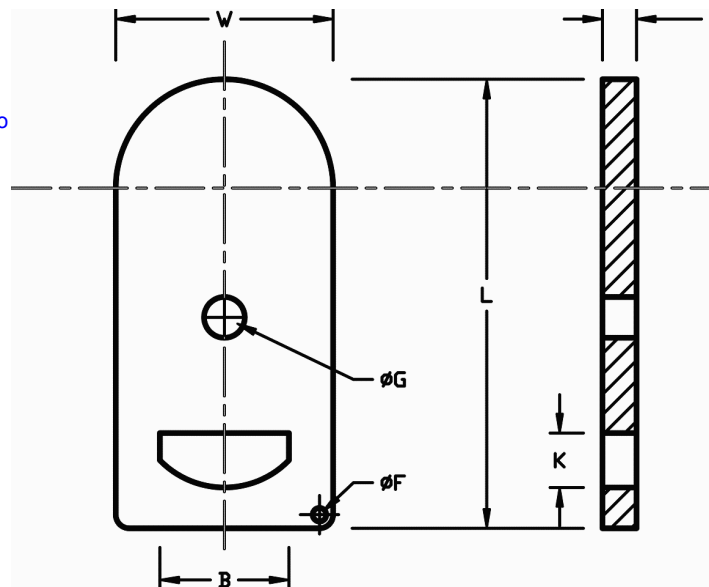

| Dimensions | | |
|------------|------|-----|
| | Inch | mm |
| L = | 5.1 | 129 |
| W = | 1.8 | 45 |
| N = | n/a | n/a |
| G = | 0.6 | 15 |
| F = | 0.3 | 7 |
| B = | 1.0 | 25 |
| K = | 1.0 | 25 |
| T = | 0.13 | 3 |

| Weight | |
|--------|-----|
| Lbs | kg |
| 0.3 | 0.1 |

| Markings |
|--|
| STEINMANS A 240 - 316 SS 150# 1/2 1/8 THK |

| Inverted Bottom Marking |
|-------------------------|
| 150# 1/2 |

- Notes:
- (1) Marking: Safety Blanks shall be permanently marked as follows:
 - (a) STEINMANS
 - (b) Material specification and grade (abbreviated)
 - (c) Flange class (abbreviated)
 - (d) Pipe Size (NPS)
 - (e) Thickness (Inches)
 - (2) Hole size "G", shall be the same size as the flange bolt hole.
 - (3) Customer to provide all required design specifications prior to placing order. Design Specifications are as follows:
 - (a) Pipe Size, NPS
 - (b) Flange Class and type
 - (c) Material
 - (d) Special coatings (if any)
 - (e) Added corrosion thickness value (if any)
 - (4) Steinmans Safety Blinds are not designed to withstand high pressures and/or temperatures. They are to be used for temporary line blocking for potential flow only. To be used in non-energized systems.

STEINMANS, LLC

4142 Ogletown-Stanton Rd. Ste. 117
 Newark, DE 19713
 Phone: (302) 999-1784
 Fax: (302) 999-1785
sales@steinmansllc.com
www.steinmansllc.com

Copyright (c) 2010 Steinmans, LLC. All Rights Reserved.