

STEINMANS SAFETY BLIND - RAISED FACE OR PLAIN FACE FLANGES

Client Name:	Provided by: Steinmans, LLC	Item No.: SB-0150-12HF-1000-316SS	Revision: REV-01
Company:	Prepared by: DSF	Design Type: STEINMANS Safety Blind	Date: 09/17/2010

- Quantity: 1
- Item Description: STEINMANS Safety Blind
- Line Size, NPS: 10
- Material of Blank/Spacer: ASTM A 240 Gr. 316 Stainless Steel Pl. 16Cr-12Ni-2Mo
- Flange Class Rating: Class 150
- Facing Type: Plain Face
- Facing Finish: Mill Finish
- *Standards: (a) ASME B16.5 Flanges, NPS 1/2 thru 24
(b) ASME B16.48 Line Blanks
(c) ASME B31.3 Process Piping
- Dimensional Tolerance: +/- 0.03 in.
- Thickness Tolerance: ASTM Plate Standard
- Weight Density (lb/in³): 0.289
- Corrosion Allowance: 0.000 in.
- Design Temperature: N/A
- Allowable Pressures (psig): NOT RATED FOR PRESSURE
- Construction of Design: One Piece Construction
- Material of Handle/Web: N/A - Handle Not Separate (One Piece Construction)
- Welding Requirements: No Welding Required (One Piece Construction)
- Coating: None
- Special Features: None

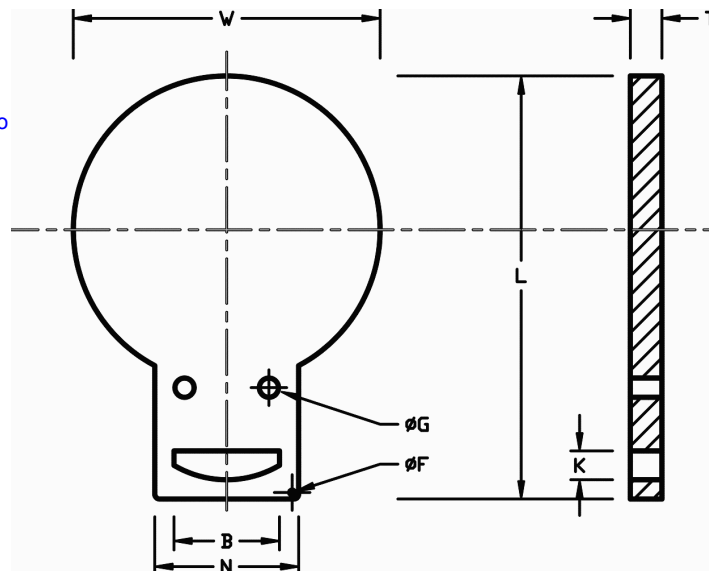

Dimensions		
	Inch	mm
L =	19.1	485
W =	13.3	337
N =	7.5	190
G =	1.0	25
F =	0.3	7
B =	5.5	139
K =	1.5	38
T =	0.13	3

Weight	
Lbs	kg
6.4	2.9

Markings
STEINMANS A 240 - 316 SS 150# 10 1/8 THK

Inverted Bottom Marking
150# 10

- Notes:
- (1) Marking: Safety Blanks shall be permanently marked as follows:
 - (a) STEINMANS
 - (b) Material specification and grade (abbreviated)
 - (c) Flange class (abbreviated)
 - (d) Pipe Size (NPS)
 - (e) Thickness (Inches)
 - (2) Hole size "G", shall be the same size as the flange bolt hole.
 - (3) Customer to provide all required design specifications prior to placing order. Design Specifications are as follows:
 - (a) Pipe Size, NPS
 - (b) Flange Class and type
 - (c) Material
 - (d) Special coatings (if any)
 - (e) Added corrosion thickness value (if any)
 - (4) Steinmans Safety Blinds are not designed to withstand high pressures and/or temperatures. They are to be used for temporary line blocking for potential flow only. To be used in non-energized systems.

STEINMANS, LLC

4142 Ogletown-Stanton Rd. Ste. 117
Newark, DE 19713
Phone: (302) 999-1784
Fax: (302) 999-1785
sales@steinmansllc.com
www.steinmansllc.com