

STEINMANS SAFETY BLIND - RAISED FACE OR PLAIN FACE FLANGES

Client Name:	Provided by: Steinmans, LLC	Item No.: SB-0300-16HF-1000-A36CS	Revision: REV-01
Company:	Prepared by: DSF	Design Type: STEINMANS Safety Blind	Date: 09/17/2010

- Quantity: 1
 Item Description: STEINMANS Safety Blind
 Line Size, NPS: 10
 Material of Blank/Spacer: ASTM A36 Carbon Steel Pl.
 Flange Class Rating: Class 300
 Facing Type: Plain Face
 Facing Finish: Mill Finish
 *Standards: (a) ASME B16.5 Flanges, NPS 1/2 thru 24
 (b) ASME B16.48 Line Blanks
 (c) ASME B31.3 Process Piping
 Dimensional Tolerance: +/- 0.03 in.
 Thickness Tolerance: ASTM Plate Standard
 Weight Density (lb/in³): 0.289
 Corrosion Allowance: 0.000 in.
 Design Temperature: N/A
 Allowable Pressures (psig): **NOT RATED FOR PRESSURE**
 Construction of Design: One Piece Construction
 Material of Handle/Web: N/A - Handle Not Separate (One Piece Construction)
 Welding Requirements: No Welding Required (One Piece Construction)
 Coating: Shop Paint (Flat Black)
 Special Features: None

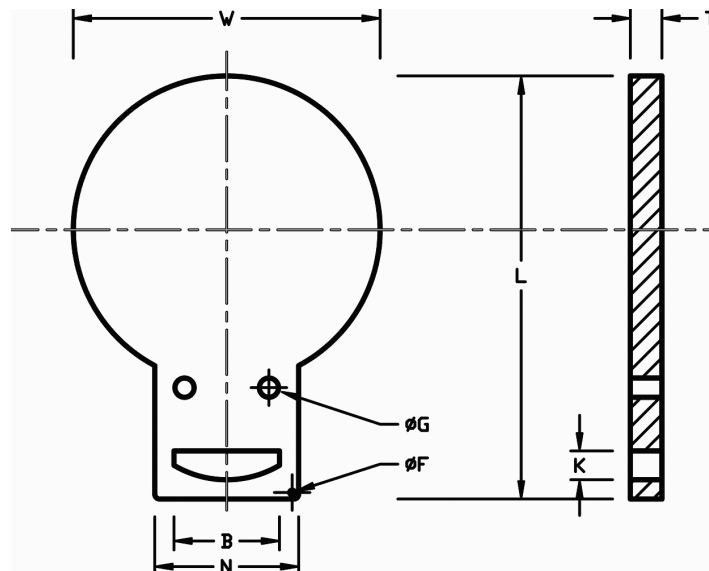

Dimensions		
	Inch	mm
L =	20.3	515
W =	14.1	358
N =	6.0	152
G =	1.1	27
F =	0.3	7
B =	4.0	101
K =	1.5	38
T =	0.13	3

Weight	
Lbs	kg
6.8	3.1

Markings
STEINMANS A 36 - CS 300# 10 1/8 THK

Inverted Bottom Marking
300# 10

- Notes:
- (1) Marking: Safety Blanks shall be permanently marked as follows:
 - (a) STEINMANS
 - (b) Material specification and grade (abbreviated)
 - (c) Flange class (abbreviated)
 - (d) Pipe Size (NPS)
 - (e) Thickness (Inches)
 - (2) Hole size "G", shall be the same size as the flange bolt hole.
 - (3) Customer to provide all required design specifications prior to placing order. Design Specifications are as follows:
 - (a) Pipe Size, NPS
 - (b) Flange Class and type
 - (c) Material
 - (d) Special coatings (if any)
 - (e) Added corrosion thickness value (if any)
 - (4) Steinmans Safety Blinds are not designed to withstand high pressures and/or temperatures. They are to be used for temporary line blocking for potential flow only. To be used in non-energized systems.

STEINMANS, LLC

4142 Ogletown-Stanton Rd. Ste. 117
 Newark, DE 19713
 Phone: (302) 999-1784
 Fax: (302) 999-1785
sales@steinmansllc.com
www.steinmansllc.com

Copyright (c) 2010 Steinmans, LLC. All Rights Reserved.