

## STEINMANS SAFETY BLIND - RAISED FACE OR PLAIN FACE FLANGES

<b>Client Name:</b>	<b>Provided by:</b> Steinmans, LLC	<b>Item No.:</b> SB-0900-12HF-0800-316SS	<b>Revision:</b> REV-01
<b>Company:</b>	<b>Prepared by:</b> DSF	<b>Design Type:</b> STEINMANS Safety Blind	<b>Date:</b> 09/17/2010

- Quantity: 1
- Item Description: STEINMANS Safety Blind
- Line Size, NPS: 8
- Material of Blank/Spacer: ASTM A 240 Gr. 316 Stainless Steel Pl. 16Cr-12Ni-2Mo
- Flange Class Rating: Class 900
- Facing Type: Plain Face
- Facing Finish: Mill Finish
- \*Standards: (a) ASME B16.5 Flanges, NPS 1/2 thru 24  
(b) ASME B16.48 Line Blanks  
(c) ASME B31.3 Process Piping
- Dimensional Tolerance: +/- 0.03 in.
- Thickness Tolerance: ASTM Plate Standard
- Weight Density (lb/in<sup>3</sup>): 0.289
- Corrosion Allowance: 0.000 in.
- Design Temperature: N/A
- Allowable Pressures (psig): **NOT RATED FOR PRESSURE**
- Construction of Design: One Piece Construction
- Material of Handle/Web: N/A - Handle Not Separate (One Piece Construction)
- Welding Requirements: No Welding Required (One Piece Construction)
- Coating: None
- Special Features: None

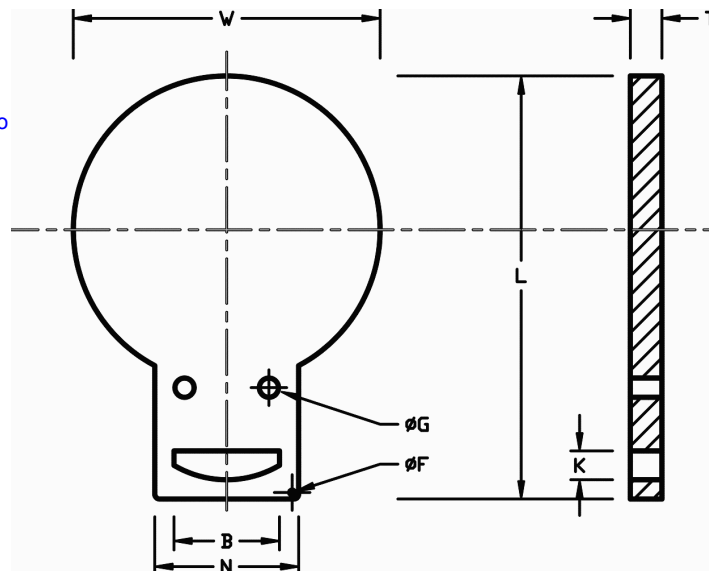

Dimensions		
	Inch	mm
L =	20.8	528
W =	14.0	355
N =	7.5	190
G =	1.5	38
F =	0.3	7
B =	5.5	139
K =	1.5	38
T =	0.13	3

Weight	
Lbs	kg
7.1	3.2

Markings
STEINMANS A 240 - 316 SS 900# 8 1/8 THK

Inverted Bottom Marking
900# 8

- Notes:
- (1) Marking: Safety Blanks shall be permanently marked as follows:
    - (a) STEINMANS
    - (b) Material specification and grade (abbreviated)
    - (c) Flange class (abbreviated)
    - (d) Pipe Size (NPS)
    - (e) Thickness (Inches)
  - (2) Hole size "G", shall be the same size as the flange bolt hole.
  - (3) Customer to provide all required design specifications prior to placing order. Design Specifications are as follows:
    - (a) Pipe Size, NPS
    - (b) Flange Class and type
    - (c) Material
    - (d) Special coatings (if any)
    - (e) Added corrosion thickness value (if any)
  - (4) Steinmans Safety Blinds are not designed to withstand high pressures and/or temperatures. They are to be used for temporary line blocking for potential flow only. To be used in non-energized systems.

### STEINMANS, LLC

4142 Ogletown-Stanton Rd. Ste. 117  
Newark, DE 19713  
Phone: (302) 999-1784  
Fax: (302) 999-1785  
[sales@steinmansllc.com](mailto:sales@steinmansllc.com)  
[www.steinmansllc.com](http://www.steinmansllc.com)

Copyright (c) 2010 Steinmans, LLC. All Rights Reserved.